

Company Profile

ORIENTAL CERAMICS SND BHD (OCSB) was established in 1975 as a member of Claytan Group to manufacture fine English Earthenware & Vitrified Hotelware under the Claytan brand.

Combining a long history of experience and with manufacturing technology and know-how from Japan and England, the company is one of the very few manufacturers outside the UK capable of producing "footless glazed profile" and "Protective glaze decoration". .

Claytan Tableware combines classic, tradition and modernity in aesthetics and functionality. Our wide variety of creative English Earthenware design with unique Underglaze Decoration technique give consumers' choices and selection that can match with their own style and find something that is appropriate for every occasion.

In supporting our commitment to keep up with the latest trends and applications our Design Department works closely with top end designers and materials suppliers in Europe.

Today, OCSB has grown to be a world class ceramics tableware manufacturer and preferred OEM producers, supply to many companies well known for their international brands like Spode, Johnson Brothers, Wade Ceramics and others. Our company philosophy of trust, worthiness, responsibility, continuous improvement and customer intimacy enables us to create continuous partnerships with our extensive customer base.

With the Claytan name established worldwide, its products are manufactured to suit your lifestyle, with a diversified range of designs and innovations to cater for your every need.

Touch the difference

YES! There are no lumps, no emboss...
You simply can't feel its design,
just its smooth surface.



We provide protective glaze
to make sure that the design will stay on your plate
and not on your food.

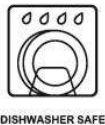

Even the bottom of our plates is so smooth, it's guaranteed not to scratch table surfaces
or other plates when you stack them on top of the other

Lifetime NO COLOR FADING of DESIGNS
Lifetime NO LEAD & CADMIUM Poisoning
Lifetime NO TOXIC Generated due to High Temperature

Claytan®

TABLEWARE

100% Malaysian Made Products



#30 - ANEMONE DARK BLUE



Turquoise (209TS)

Decor No: 209BS



#30 - ASTER PINK



Blue (1505BS)

Decor No: 1505PS



#120K - AURORA BLUE



Positive
(1605BS)



Negative
(1605BS)



Beige Positive
(1605ES)

Decor No: 1605BS



#200 - BATIK BLUE



Beige (203ES)

Decor No: 203BS



#30L - BELMONT DARK BLUE

Decor No: 1603BS



#30 - BETTY BLUE

Decor No: 315BS



#120K - BOHEME PINK



Purple
(107US)

Blue
(107BS)

Ice Blue
(107CS)

Decor No: 107PS



#30 - BUFF BEAUTY BEIGE



Blue (310BS)

Pink (310PS)

Decor No: 310ES



#90 - CALIFORD BLACK



Maroon
(1519PS)

Decor No: 1519LS



#30 - CAMILLE PINK



Blue (150BA) Green (150G) Grey (150L) Purple (150U) Jade Green (150J)

Turquoise (150T)

Decor No: 150P



#240 - CITY

Decor No: 9000



#240 - CITY WITH GOLD BANDING



City with Platinum
BANDING (415ZS)

Decor No: 415XS

(IVORY BODY)



#120K - CLARISSA PINK



Purple (014US)

Decor No: 014PS



#30L - COTTAGE GARDEN BLUE



Brown (201RS)



Pink (201PS)

Decor No: 201BS



#30 - DAISY DAMASK FULL BLACK



Blue (803BS)



Navy (803NS)



Pink (803PS)

Decor No: 803LS



#30 - DAMASK FULL BLACK



Blue (0431B)



Beige (0431E)



Pink (0431P)



Purple (0431U)

Decor No: 0431L



#30 - DECO BLACK



Pink (018PS)



Purple (018US)



Beige (018ES)

Decor No: 018LS



#30 - DELFT FLORAL BLUE



Navy (405NS)

Decor No: 405BS



#30 - DIANA ROSE JADE GREEN



Blue (9911B)



Pink (9911P)



Brown (9911R)

Decor No: 9911J



#30L - DIVINE DARK BLUE

Decor No: 1604BS



#90 - ENGLISH LACE BEIGE



Pink (106PS)

Decor No: 106ES



#30L - FLORAL LATTICE BLUE



Grey (102LS)

Pink (102PS)

Decor No: 102BS



#30 - GARDEN ROSE SEASON PINK



Purple (1614US)

Decor No:1614PS



#30 - GORGEOUS GREY



Blue (1503BS)

Beige (1503ES)

Decor No:1503LS



#30 - GRACE PURPLE



Pink (314PS)

Decor No: 314US



#30 - HAYDON GARDEN

Decor No: 320RS



#90 - HENNA BLUE

Decor No: 1615BS



#30 - HORSE CART BLUE



Green (0421G)

Decor No: 0421B



#120K - IMPRESSION FLORAL
MAROON



Black
(1602LS)

Decor No: 1602PS



#30 - ISABELLA BLUE



Green (809GS)



Pink (809PS)

Decor No: 809BS



#30 - KENSINGTON BLUE



Pink (902PS)

Decor No: 902BS



#90 - KESHI KEEBA

Decor No: 112



#90 - LAGNY PINK



Blue
(1504BS)

Decor No: 1504PS



#250 - LISE GREY



Lise Beige (303ES)

Decor No: 303LS

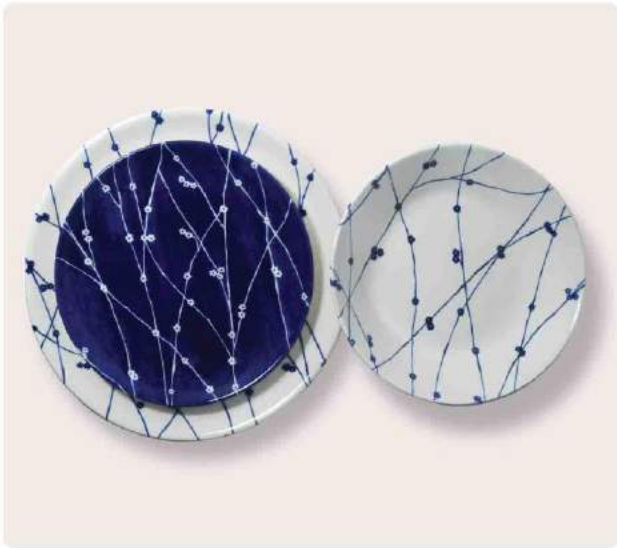

#120K - LUCY BLUE



Pink (104PS)

Decor No: 104BS



#800 - MAPLE HILL

Decor No: 710



#200 - MARBLE GREY



Beige (905ES)

Decor No: 905LS



#90 - MARISSA GREEN

Decor No: 919GS



#90 - ONION BLUE



Navy (202NS)

Decor No: 202BS



#90 - ORIENTAL ROSES BLUE



Pink (0621P)



Beige (0621E)

Decor No: 0621B



#30L - PEMBERLY BLUE



Brown (301RS)



Pink (301PS)

Decor No: 301BS



#90 - PETITE POULE BEIGE



Pink (0707P)



Jade (0707J)



Blue (0707B)

Decor No: 0707E



#30 - PINK GLAZE WITH GOLD BANDING



Blue Glaze With Platinum Banding (1515ZS)

Decor No: 1515XS



#90 - PLAID BLACK



Pink (0706P)

Decor No: 0706L

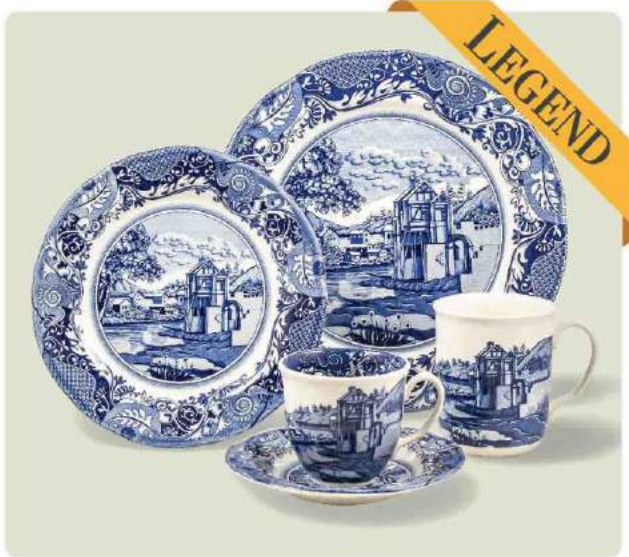

#30L - RIVER BLUE

Decor No: 402BS



#30L - ROME BLUE

Decor No: 404BS



#30 - ROSE GARDEN BLACK



Blue (9762B) Pink (9762M) New Pink (9762P) Beige (9762E)

Decor No: 9762L



#30 - ROSETTA BLACK



Blue (5305B) Beige (5305E) Pink (5305P) Green (5305G)

Decor No: 5305L



#30 - ROSE WEAVE BLUE



Brown (0701R)



Pink (0701P)



Beige (0701E)

Decor No: 0701B



#30 - ROYAL CROWN GREEN



Blue (308BS)



Pink (308PS)

Decor No: 308GS



#30 - ROYALE CLASSIQUE BLUE



Black (5341L)



Pink (5341P)

Decor No: 5341B



#200 - SAFARI BLUE

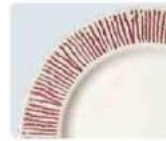

Pink (2104P)



Purple (2104U)



Yellow (2104Y)

Decor No: 2104B



#90 - SHABBY CHIC PINK



Turquoise
(1509TS)

Decor No: 1509PS



#30 - SPLENDOR PURPLE



Blue (9727B)

Beige
(9727E)

Brown
(9727R)

Light Pink
(9727V)

Dark Bruish Green
(9727D) (salad plate)



Pink (9727P)
(Salad Plate)

Decor No: 9727U



#30L - SUDBURY BROWN



Blue (302BS)

Decor No: 302RS



#120/90 - SUZANI AMBER



Blue
(1506BS)



Brown
(1506RS)



Beige
(1517ES)

Decor No: 1506AS (Rim) - 1517ES (Full)



#120K - SYNERGY BLUE

Decor No: 1502BS



#30 - TOILE DE JOY PURPLE

Decor No: 002US



Blue
(002BS)

Beige
(002ES)

Pink
(002PS)

Brown
(002RS)



#30 - VECFLORAL BLUE



Maroon
(1613PS)

Decor No: 1613BS



#30L - VICTORIA BLUE



Pink (403PS)

Decor No: 403BS



#90 - VINTAGE BEIGE



Black (0703L)

Decor No: 0703E



#30 - WATERWHEEL BLUE



Brown (307RS)



Pink (307PS)



Green (307GS)

Decor No: 307BS



#90 - WILLOW BLUE

Decor No: 001BS



#30 - WINDMILL BLUE



Pink (185P)



Brown (185R)



Green (185G)

Decor No: 185B



#120K - AMELIA

Decor No: 412FS



#90 - ARCY



Border
(309FS)



All-over
(309FA)

Decor No: 309FS



#120K - AUTUMN FLOWER

Decor No: 305FA



#120K - BANDINGS GREEN



Bandings Red
(128FS)



3 Line Banding
(101FS)

Decor No: 208FS



#90 - BIG FLOWER

Decor No: 419FS



#70 - BLUE BONNET with BROWN BANDING

Decor No: 602



#120K - BOTANICAL SPIRAL



Twiggy(1625FS)

Decor No: 1607FS



#30 - BUTTERFLY BLUE

Decor No: 420FS



#200 - CABALA BEIGE



007FB

Decor No: 007FA (BORDER) - 007FC (DOTS)



#200 - CABALA PEACH



004FC

Decor No: 004FA (BORDER) - 004FB (LINE)



#90 - CACHEMIRE

Decor No: 411FS



#90 - CALIKA YELLOW

Decor No: 1617FS



#30 - CHARTWELL 'V' with BANDING



Chartwell Full
(0310F)



Chartwell 'V'
(0311F)



Chartwell Rim
(0316F)

Decor No: 0422F



#70 - CHERRY BLOSSOM



With Banding
(601)

Decor No: 601N



#30 - CHRYSLER IMPERIAL

Decor No: 012FS



#90 - COSMO GARDEN



Border
(1618FS)



All-over
(1619FS)

Decor No: 1618FS



#30 - COTTAGE ROSE With BANDING

Decor No: 1511FS



#90 - COUNTRY FARMYARD



Center
(1508FA)



All-over
(1508FS)

Decor No: 1508FA (Center) - 1508FS (All-Over)



#30 - CRIMSON

Decor No: 413FS / FA / FB



#30 - DAMASK FLOWER PINK



Beige (0430F)



Pink (0426F)



Pink Without
Flower (0428F)



Pink Border
(0429F)

Decor No: 0427F



#200 - EDEN PINK



Blue (1518BS)

Decor No: 0704F



#30 - ELEGANT FLORAL

Decor No: 416FS



#30 - EVANGELINE with GOLD BANDING



Evangeline (921FS)

Decor No: 921XS



#30 - EVET

Decor No: 1609FS



#90 - FELICITY

Decor No: 313FS



#30 - FLORET RIM DARK BLUE

Decor No: 0410F



Floret Full
Dark Blue (0408F)



Floret Border
Dark Blue (0409F)



#30 - FLORET RIM PINK

Decor No: 0306N (Full) - 0308N (Rim)



Floret Border Pink
(0307N)



Floret Rim
(0308FS)



Full Yellow
(311FS)



#90 - FLORID

Decor No: 406FS



#90 - FRAGRANCE ROSES



Big (410FS)

Decor No: 410FA



#90 - FRUIT SEASON with Blue plum



Big (418FA)

Decor No: 418FS



#90 - FRUIT SEASON with Purple plum



Small (407FS)

Decor No: 407FA



#30 - GORGEOUS FULL

Decor No: 1501FS



#30 - HAYDON GROVE

Decor No: 408FA



#120K- HYDRANGEA GARDEN

Decor No: 1514FS



#120K- LAURA

Decor No: 1608FS



#120K- MAKAYLA

Decor No: 1624FS



#30 - MOSS ROSE

Decor No: 206FS



#30 - NEW ORCHARD

Decor No: 910FA Apple - 910FB Pear
910FC Cherry - 910FD Blueberry



#90 - PASSION BLOSSOM

Decor No: 409FS



#30 - PETUNIA

Decor No: 1510FA



#90 - PIMPRENELLE

Decor No: 422FS



#90 - REBECCA PINK



Border
(1621FS)



All-over
(1622FS)

Decor No: 1621FS



#30 - ROSABUNDA

Decor No: 805FS



#90 - ROSEBY WHITE

Decor No: 9803W



#90 - ROSE MUNDI

Decor No: 0623F



#120K - SPOT RED

Decor No: 421FS



#90 - SPRING FLORAL

Decor No: 1612FS



#90 - STRIPES PINK

Decor No: 213FS



#120K - SUMAYA BLUE

Decor No:1611FS



#120K - SUMAYA MAROON

Decor No:1610FS



#30 - T'IS THE SEASON

Decor No: 760



#30 - VANTAGE VALLEY FULL

Decor No: 1512FS



#120K - WEAVE

Decor No: 926FS



#120K - WILD FLOWER

Decor No: 318FS



#30 - WILD ROSE with BANDING



Without Banding
(0501F)

Decor No: 0502F



#120K - WINSOME

Decor No: 1507FS



#V310 - BABY ELEPHANT

Decor No: 125FS



#V310 - FUN CARS

Decor No: 127FS



#V310 - SUMMER THINGS

Decor No: 126FS



#540 - NOODLE CUP (VEGGIE)



Chicken (319FA)



Beef (319FB)



Seafood (319FC)

Decor No: 319FD

WHAT ARE THE BENEFITS?

- **Safe to use** even for very hot serving.
- **Scratch resistance** –no dirty stain mark on wares surface even using over long period.
- **Ultra high chipping resistance** makes this ceramic children ware safer to use.
- **More slip resistance to handling** is possible from the dedicated embossed shape.
- **Anti bacteria glaze** give extra protection to our love ones.
- **Underglaze decoration** method makes the ware Leadsafe; and the **decoration stays freshly new** to the life of the ware.
- **Other Claytan ware features**



Microwave - Safe



Freezer

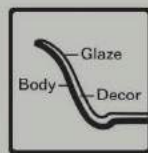

Underglaze Decoration



Dishwasher - Safe







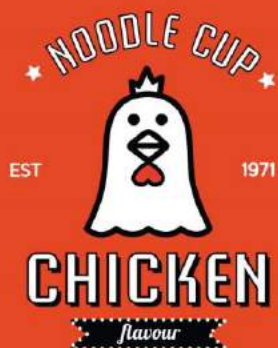
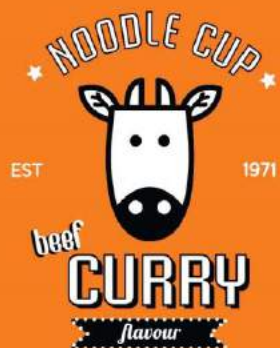

Lead Safe





★ BENEFITS OF USING MY NOODLE CUP ★

-  SAFE FROM TOXINS RELEASED PLASTIC CONTAINERS WHEN FILLED WITH BOILING WATER
-  TASTE THE ORIGINAL FLAVOUR OF NOODLES WITHOUT THE PLASTIC ODOUR
-  SAFE FROM SCALDING YOUR FINGERS WITH THE HANDY CUP HANDLE
-  WELL-GLAZED AND HYGIENIC LID CAN DOUBLE AS COASTER OR A SMALL DISH
-  SUITABLE FOR USE ANYWHERE: AT HOME OR FOR TRAVEL
-  SAVE MONEY AND SAVE OUR EARTH FROM NON-BIODEGRADABLE WASTE OF PLASTIC CONTAINER DISPOSAL
-  HEALTHY PRACTICAL AND AFFORDABLE GIFT FOR YOU, FRIENDS AND YOUR LOVED ONES



MICROWAVE SAFE



FREEZER SAFE



UNDERGLAZE
DECORATION

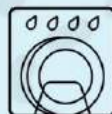

DISHWASHER SAFE



LEAD SAFE



DESIGN REG NO.
MY 12-01395-0101

Claytan (Underglaze) VS Other (Onglaze)

Underglaze Decoration - Claytan Method

For underglaze Tableware, the decal is fired at high temperature on the tableware body. Then it is sealed by the glaze layer and fired again at even higher temperature. The result is the decal is permanently protected and no chance at all the color will come in contact with the food → Food safe! And as the decal will not fade, it looks as new at all time!

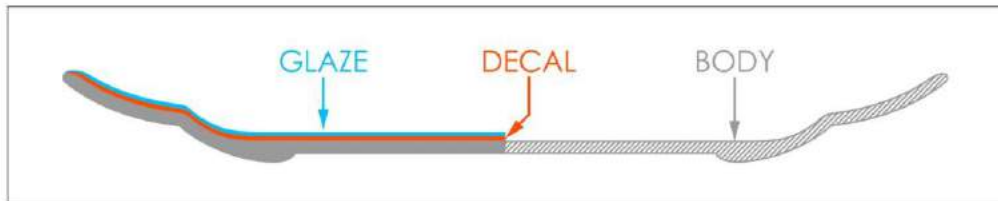

Onglaze Decoration Other Method

For onglaze tableware, the decal is fired at lower temperature on the tableware surface, therefore it is not permanent. The decal/color could be removed over some period of usage. It cause the decal will look faded. The removed decal could be swallowed into our stomach. Eating color from the decal that contains lead cadmium will be harmful to one's health.

How to test?

If you can feel the contour of the decal by finger nail on the tableware surface, then a high possibility that the decal is onglaze.

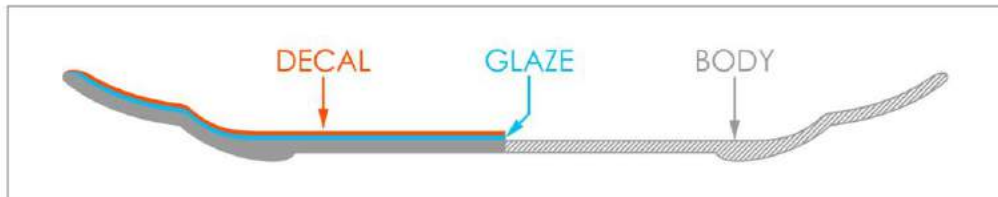

Claytan® Glazed Foot
TABLEWARE



CLAYTAN FIRING METHOD



BY BRITISH "3-PIN FIRING"

The pin marks on the bottom of Claytan ware are not defects. They are the marks of pins which are used for supporting the wares during firing.

With this unique British "3-Pin Firing" process, we are able to totally glaze the foot of our wares for smooth finishing. Smooth foot tableware will not cause expensive table surface being scratched. It will also not scratch the piece below it when stacked together.

SHAPE SPECIFICATIONS FOR 30 / 30N / 30S / 30L

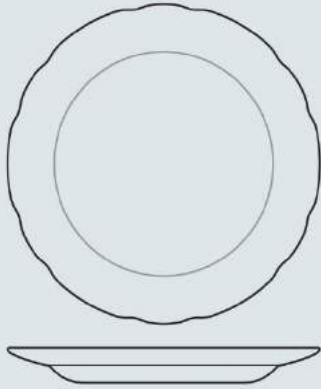

CHOP PLATE - 12.1" 30.9CM

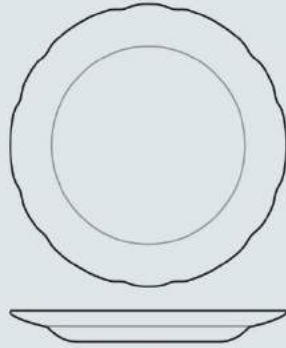

DINNER PLATE - (#30L) 10.7" 27.3CM
 DINNER PLATE - 10.2" 26CM
 MEAT PLATE - 9.2" 23.5CM
 SALAD PLATE - 8.1" 20.7CM
 SALAD PLATE - 7.3" 18.5CM
 BB PLATE - 6.1" 15.6CM

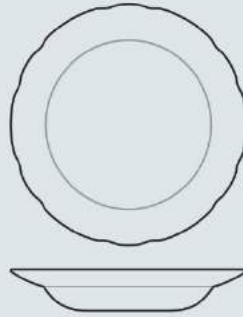

SOUP PASTA - 9.2" 23.3CM
 SOUP PLATE - 8.0" 20.3CM
 SOUP PLATE - 7.3" 18.7CM

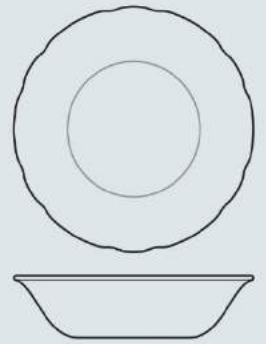

SALAD BOWL - 9.3" 23.7CM
 SOUP BOWL - 7.0" 17.9CM
 CEREAL BOWL - 6.2" 15.7CM



TEAPOT - (#30L) / LID (#30L)
 1280ML 45 OZ



TEAPOT - (#30) / LID (#30N)
 965ML 34.0 OZ



TEAPOT - (#30S) / LID (#30N)
 940ML 33.1 OZ



WATER PITCHER - 930ML
 32.7 OZ



CUP - (#30L) 240ML 8.4OZ &
 SAUCER - #30L 6.2" 15.7CM



CUP - (#30N) 200ML 7.1 OZ &
 SAUCER - 6.1" 15.6CM



CUP - (#30S) 205ML &
 SAUCER - 6.1" 15.6CM



ESPRESSO CUP
 (#30N) 90ML 3.2OZ
 SAUCER - 4.8" 12.3CM



MUG 340ML 12.0 OZ

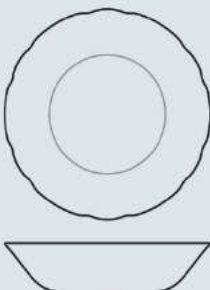

SIAM RICE BOWL - 8.0" 20.3CM



FRUIT DISH - 5.4" 13.7CM
 FRUIT DISH - 6.4" 16.4CM



GRAVY SERVER - 420ML 14.8 OZ



SUGAR BOWL / LID
 (#30N) 280ML 9.9 OZ



CREAMER - 210ML 7.4 OZ

SHAPE SPECIFICATIONS FOR 30 / 30N / 30S / 30L

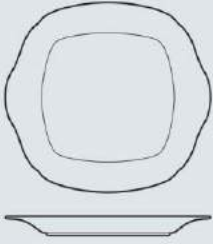

SERVING TRAY - 10.8" 27.4CM



CANDY DISH - 6.6" 16.7CM



TUMBLER - 235ML 8.3 OZ

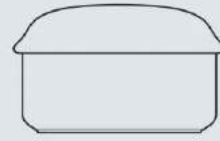

COVERED BOWL / LID
4.1" 10.5 CM



SALT & PEPPER SHAKER
2.3" 5.9 CM

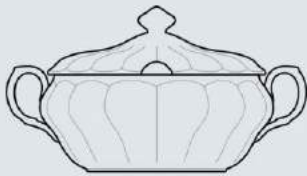

CASSEROLE / LID WITH HOLE
9.2" 23.5CM
2650ML 93.3OZ



SOUP TUREEN / LID WITH HOLE
9.2" 23.5CM
2900ML 102.1OZ



CASSEROLE / LID
9.2" 23.5CM
2650ML 93.3 OZ



SOUP TOUREEN / LID
9.2" 23.5CM
2900ML 102.1 OZ



SOUP TOUREEN (#30L) / LID (#30)
9.2" 23.5CM
3750ML 126.2 OZ



SOUP TOUREEN (#30S) / LID (#30S)
8.3" 21CM
2500ML 84.5OZ

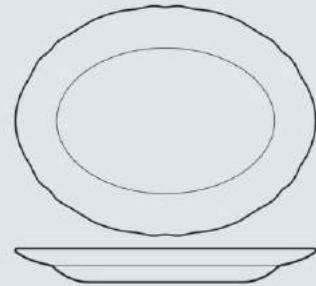

OVAL PLATTER - 14.0" 35.5CM
OVAL PLATTER - 12.0" 30.5CM
OVAL PLATTER - 10.0" 25.4CM

SHAPE SPECIFICATIONS FOR 170



MUG - 320cc 10.6oz

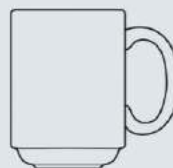

MUG - 390cc 12.3oz

SHAPE SPECIFICATIONS FOR 90 / 90A / 90K / 90N

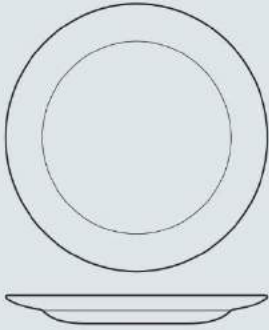

CHOP PLATE - 12.0" 30.4CM
DINNER PLATE - 10.5" 26.6CM
SALAD PLATE - 8.2" 20.9CM
BB PLATE - 6.2" 15.7CM

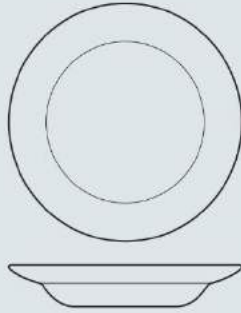

SOUP PLATE - 9.1" 23.1CM

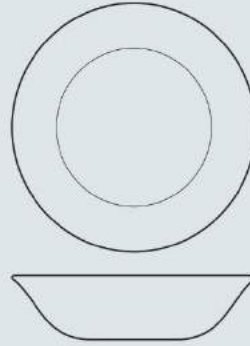

SALAD BOWL - (#92) 9.5" 24CM
SALAD BOWL - 9.2" 23.4CM
CEREAL BOWL - 6.2" 15.8CM
FRUIT DISH - 5.3" 13.6CM

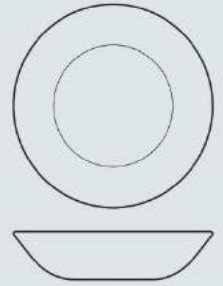

SIAM RICE BOWL - 9.0" 22.9CM
SIAM RICE BOWL - 8.0" 20.3CM
COUPE BOWL - 7.4" 18.9CM

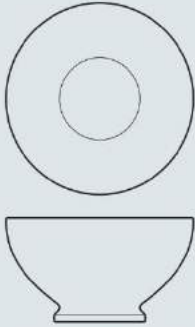

FOOTED BOWL (#90K)
5.5" 14CM

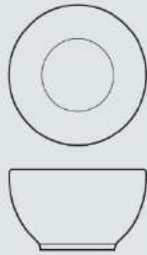

RICE BOWL 4.5" 11.6CM
SOUP BOWL 4.0" 10.0CM



CUP (#90K) 240ML 8.4 OZ
& SAUCER (#90K) 6.2" 15.8CM



ESPRESSO CUP (#90K) 95ML 3.3 OZ
& SAUCER 4.9" 12.4CM



JUMBO CUP - 490ML 17.2 OZ
& SAUCER 7.2" 18.3CM



MUG - (#90N) 370ML 13.0 OZ



TEAPOT / LID - (#90K) 1150ML 40.5 OZ



SUGAR BOWL / LID - (#90K)
370ML 13.0 OZ



CREAMER - (#90K)
240ML 8.4 OZ

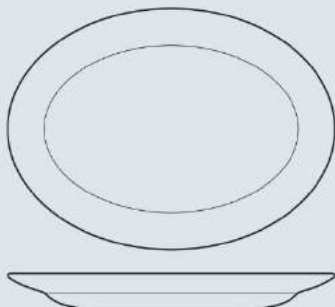

OVAL PLATTER - (#210) 14.2" 36.2CM
OVAL PLATTER - 12.1" 30.8CM
OVAL PLATTER - 10.0" 25.4CM



WATER PITCHER
1300ML 45.8 OZ



WATER PITCHER - (#90K)
1500ML 52.8 OZ

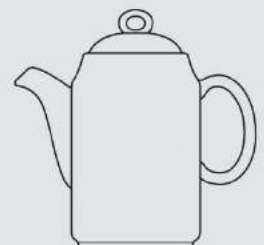

TEAPOT / LID - 1130ML

SHAPE SPECIFICATIONS FOR 90 / 90A / 90K / 90N



BUTTER DISH COVER (#90K)
(TOP VIEW) 5.8" 14.5CM



BUTTER DISH WITH COVER (#90K)
(SIDE VIEW)



BUTTER DISH (#90K)
(TOP VIEW) 7.2" 18.0CM



SALT & PEPPER SHAKER
2.0" 5.1CM



EGG CUP (#90P) 2.0" 5.1CM



GRAVY SERVER (#UK)
350ML 12.3 OZ

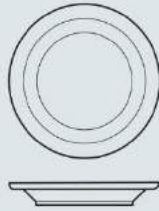

DIP DISH 4.2" 10.7CM

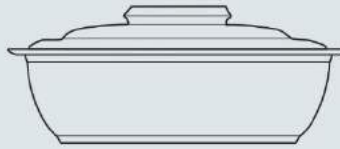

CASSEROLE / LID - 9.0" 22.8CM
CASSEROLE / LID - 8.0" 20.3CM
CASSEROLE / LID - 7.1" 18.0CM



CASSEROLE / LID (#90K)
9.0" 22.8CM 1770ML 62.3 OZ

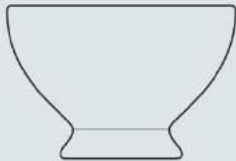

FOOTED BOWL (#90A)
5.7" 14.5CM 690cc 24.3oz
(NONE STANDARD)

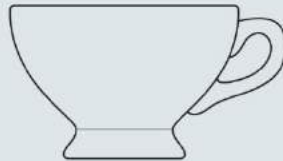

FOOTED BOWL WITH HANDLE (#90A)
5.7" 14.5CM 690cc 24.3oz
(NONE STANDARD)



FOOTED BREAKFAST CUP (#90A)
4.9" 12.5CM 430cc 15.1oz
(NONE STANDARD)

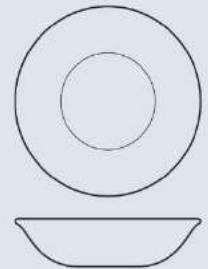

FRUIT DISH 6.4" 16.4CM

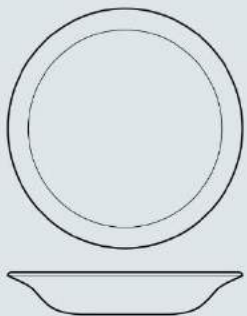

SIAM COUPE SOUP - (90K) 9.0" 22.8CM
SIAM COUPE SOUP - (90K) 8.1" 20.5CM

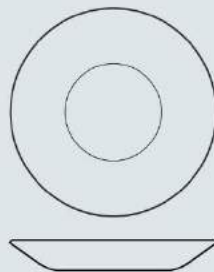

SOUP CUP SAUCER - 6.7" 17CM

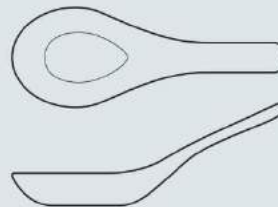

SPOON - 5" 12.5CM

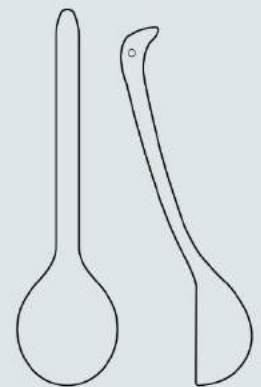

LADLE - 10.5" 26.5CM

SHAPE SPECIFICATIONS FOR 70

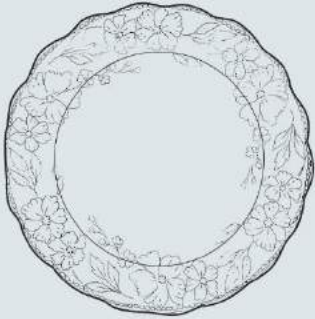

CHOP PLATE - 12.1" 30.9cm
DINNER PLATE - 10.6" 27.0cm
SALAD PLATE - 7.3" 18.7cm
BB PLATE - 6.4" 16.2cm

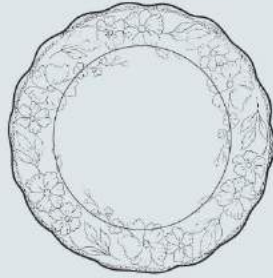

SOUP PLATE - 9.2" 23.4cm

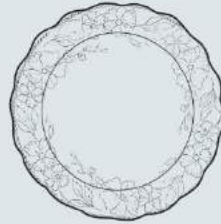

SALAD BOWL - 9.2" 23.4cm
CEREAL BOWL - 6.1" 15.6cm
FRUIT DISH - 5.3" 13.6cm



OVAL PLATTER - 14.2" 36.2cm

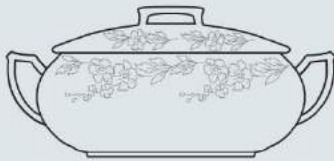

CASSEROLE / LID - 9.0" 22.8cm 2757ml 97.0 oz

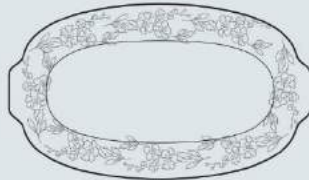

SANDWICH TRAY - 13.0" 33.0cm
SNACK TRAY - 10.0" 25.4cm



CUP - 220ml 7.7oz
& SAUCER - 6.0" 15.3cm



ESPRESSO CUP - 100ml 3.5oz
& SAUCER - 4.9" 12.5cm



TEAPOT / LID - 1190ml 41.9oz



SUGAR BOWL / LID - 220ml 7.7oz



CREAMER - 195ml 6.9oz



WATER PITCHER - 940ml 33.1oz



TUMBLER - 240ml 8.4oz



COVERED BOWL / LID
1190ml 41.9oz



GRAVY SERVER - 510ml 18.0oz

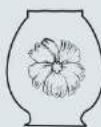

SALT & PEPPER SHAKER
2.3" 6.0cm

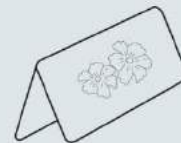

NAME PLAQUE - 2.9" 7.3cm



NAPKIN RING
1.1" 2.9cm

SHAPE SPECIFICATIONS FOR 100

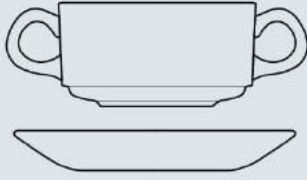

SOUP CUP with HANDLE - 4" 310cc
SOUP CUP SAUCER - 6.8"

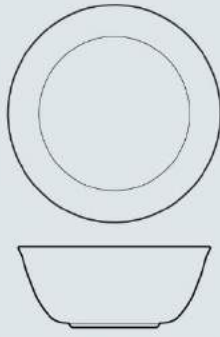

NOODLE BOWL - 7.2" 18.3cm

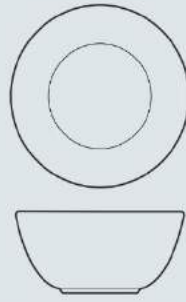

NOODLE / LAKSA BOWL - 6.2" 15.7cm

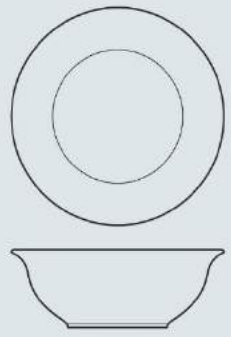

ORIENTAL BOWL - 6.9" 17.5cm

SHAPE SPECIFICATIONS FOR 120 / 120A / 120K

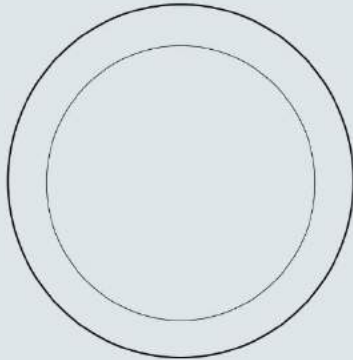

CHOP PLATE (#120K) 12.2" 31cm
DINNER PLATE (#120K) 10.6" 27.0cm
BB PLATE (120K) 6.6" 16.8cm

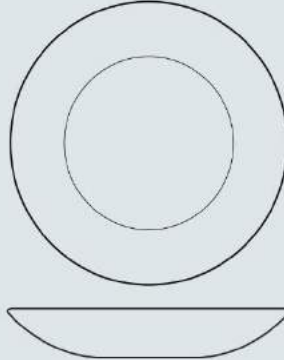

COUPE BOWL (#120K) 9.2" 23.5cm

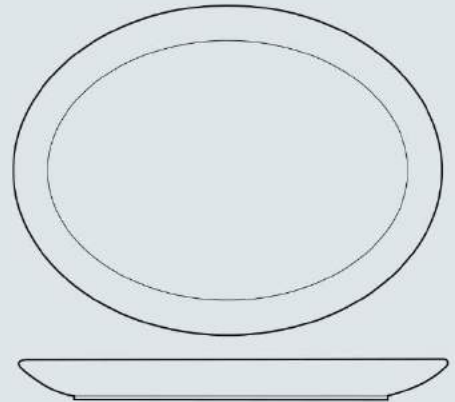

OVAL PLATTER (#120) 12.9" 32cm
OVAL PLATTER (#120K) 14.6" 37cm
OVAL PLATTER (#120) 15" 38cm
OVAL PLATTER (#120) 16" 40cm

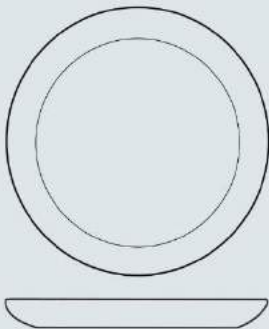

SALAD PLATE (#120K) 8.3" 21cm

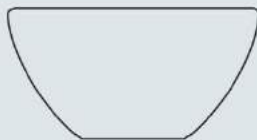

CEREAL BOWL (#120K)
5.8" 14.7cm 750cc 26.4oz

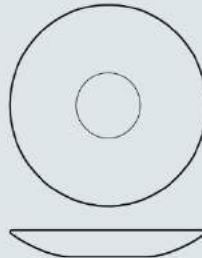

SAUCER (#120K) 5.9" 15cm



MUG (#120K) 360cc 12.7oz



CUP (#120K) 250cc 8.8oz



MUG (#120A) 360cc 12.7oz



SMALL MUG (#120A) 230cc 8.1oz

SHAPE SPECIFICATIONS FOR 200 / 210

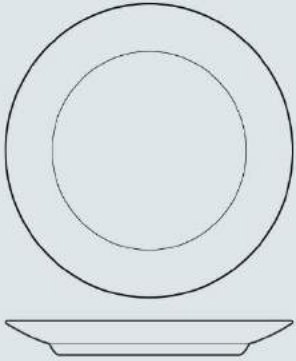

CHOP PLATE - 12.0" 30.6cm
DINNER PLATE - 10.9" 27.8cm
SALAD PLATE - 8.5" 21.6cm

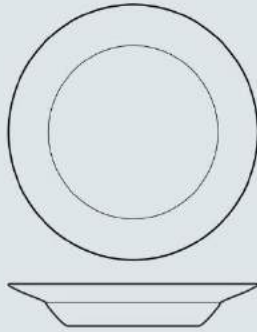

SOUP PLATE - 9.3" 23.7cm

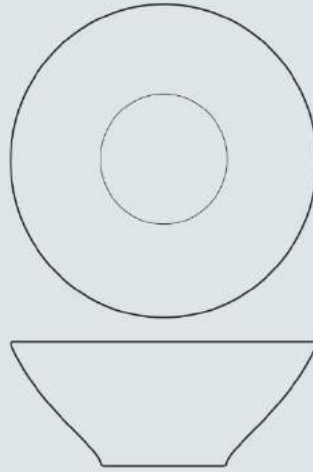

SALAD BOWL - 10.0" 25.4cm

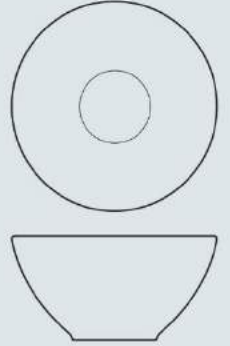

SOUP BOWL - 6.8" 17.3cm

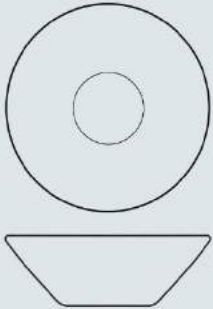

CEREAL BOWL - 6.6" 16.8cm

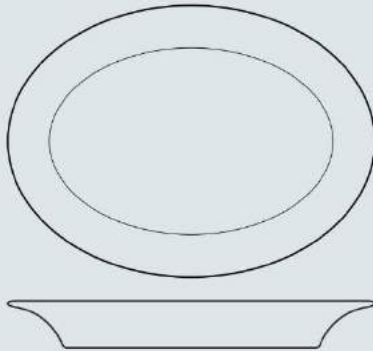

OVAL PLATTER - (#210) 14.2" 36cm

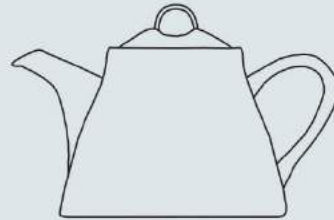

TEAPOT / LID - 1420cc 50oz



SUGAR BOWL / LID
290cc 10.2oz



CUP - 200cc 7.0oz
& SAUCER - 5.9" 14.9cm



ESPRESSO CUP 95cc 3.3oz
& SAUCER - 4.9" 12.5cm

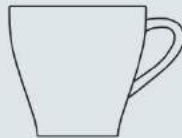

MUG - 340cc 12.0oz



CREAMER - 195cc 6.9oz



TUMBLER - 195cc 6.9oz



DIP DISH - 4.3"

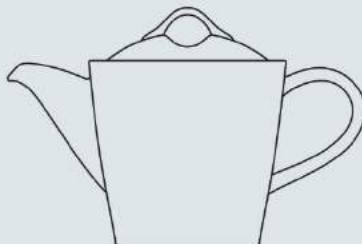

TEAPOT / LID (#210) 1100cc 38.7oz



SUGAR BOWL / LID (#210) 165cc 5.8oz

SHAPE SPECIFICATIONS FOR 240 / 240N

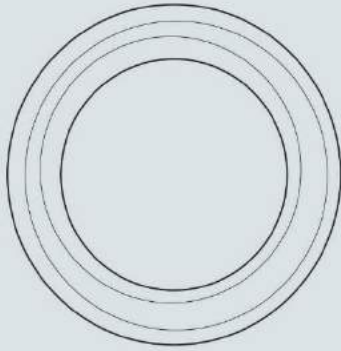

CHOP PLATE - 12.4" 31.5cm
DINNER PLATE - 10.8" 27.5cm

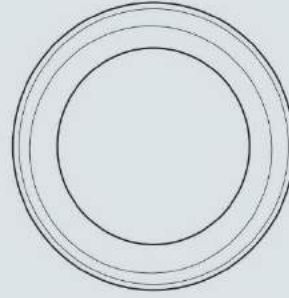

SOUP PLATE - 9" 23cm

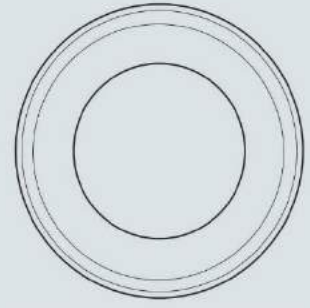

PASTA PLATE - 10" 25.5cm
PASTA PLATE - 11.8" 30cm

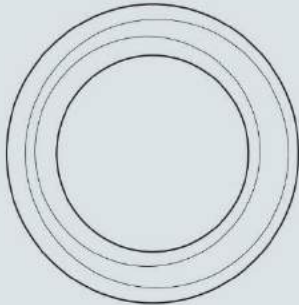

SALAD PLATE - 8.2" 21cm
BB PLATE - 6.7" 17cm

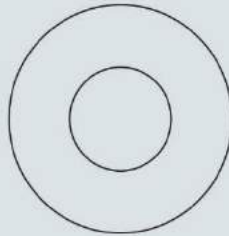

SALAD BOWL - 9" 23cm
CEREAL BOWL - 5.7" 14.5cm

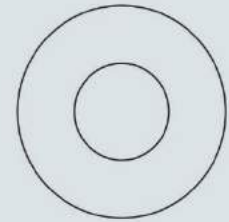

COUPE BOWL - 7.9" 20cm

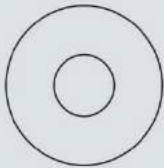

RICE BOWL - 4.4" 11.3cm
RICE BOWL - 4.9" 12.5cm 410cc 14.4oz

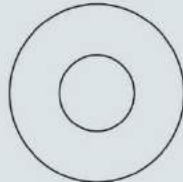

ROUND DISH - (#240N) 4" 10cm



SPOON

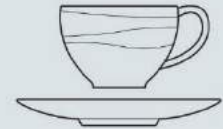
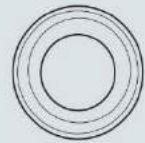

ESPRESSO CUP - 120cc 4.2oz
& ESPRESSO SAUCER - 4.7" 12cm

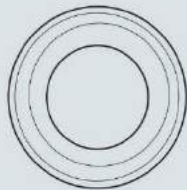

CUP - 270cc 9.5oz
& SAUCER - 6.5" 16.5cm

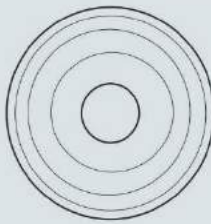

CAPPUCINO CUP - 370cc 13oz
& SAUCER - 6.5" 16.5cm



MUG - 390cc 13.7oz



MINI MUG - 220cc 7.7oz

SHAPE SPECIFICATIONS FOR 240 / 240N

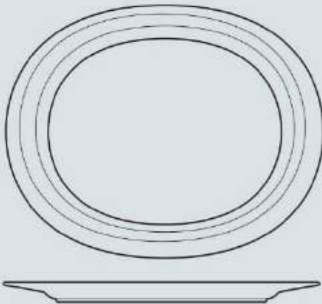

OBLONG PLATTER - 14.2" 36cm
 OBLONG PLATTER - 12" 30.5cm
 OBLONG PLATTER - 10" 25.4cm
 PICKLE DISH - 9" 23cm

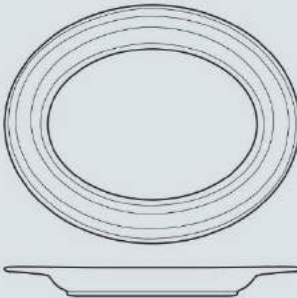

OVAL PLATTER - 16.1" 41.0cm
 40.5oz 1150cc
 OVAL PLATTER - 14.2" 36.0cm
 23.2oz 660cc



NOODLE BOWL - 8.3" 21.0cm
 52.8oz 1500cc

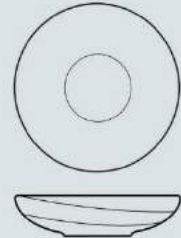

ROUND DISH - 3.9" 10.0cm
 3.5oz 100cc

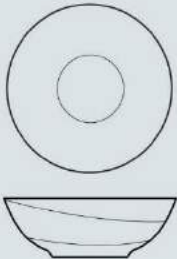

ROUND DISH - 2.8" 7.0cm
 1.8oz 50cc



TEAPOT / LID - 1300cc 45.8oz



TALL MUG - 550cc 19.4oz



CREAMER - 250cc 8.8oz



SUGAR BOWL / LID - 300cc 10.6oz

A member of Claytan Group



ORIENTAL CERAMICS SDN BHD (15466-P)

57th Mile, Jalan Johor, 86100 Ayer Hitam, Kluang, Johor Darul Takzim, Malaysia.

Tel : + 607 - 758 1201/1202 Fax : + 607 - 758 1896/1825

E-mail : oc-marketing@claytangroup.com Website : www.claytangroup.com